

Urban Atlanta House

DES 284- Residential Design, Spring 2021
 Leonor Fleming – Class of 2023

CLIENT PROFILE

A married couple, Lawrence and Erykah Walker, recently moved to the Candler Park area of Atlanta, GA. Although the couple is longstanding members of the Atlanta Community, they moved to offer better schools and safe opportunities to their three children, Amaya, Jamal, and Andre.

Mr. and Mrs. Walker are in their late forties, and both work in the music industry. Lawrence is a music producer for well-known hip-hop artists in the area, while Erykah teaches piano lessons from home to accommodate being a stay-at-home mother. Not only are the Walker parents gifted in the arts, but their children have followed suit. Amaya (15), Jamal (11), and Andre (7) all play musical instruments and spend much time perfecting their craft.

The Walkers' culture is also a significant aspect of who they are and what they believe. The Walkers support and organize programs and events for civil justice and equality. Being African American with means allows the Walkers to have a platform that others may not, so they use their resources to help the community in many areas, such as running a non-profit youth facility.

The Walkers also entertain and use their home as a hosting area for many family functions and get-togethers. As a result, the kitchen and dining areas are a must in gourmet appliances while keeping with casual living.

Overall, the Walkers' focus is music, culture, and food to represent their lifestyle and aesthetic. Old, new, and luxury will be the focus of the spaces within the Walker Residence.

CONCEPT STATEMENT

The concept of this mood board has a variety of different components. The feel is urban city life with a taste of sophistication. Remembering cultural and first roots is significant to the overall mood of this presentation. **Unity** (harmony, balance, inclusion, diversity, variety, luxury, casual, human, equality, history), **Power** (gold, bold colors, nature, culture, lyrics, sound), and **Movement** (black live matter, music, rhythm, waves, ocean, fluidity) are key factors in the images presented.

UNITY power MOVEMENT

PROCESS WORK

Bubble Diagrams

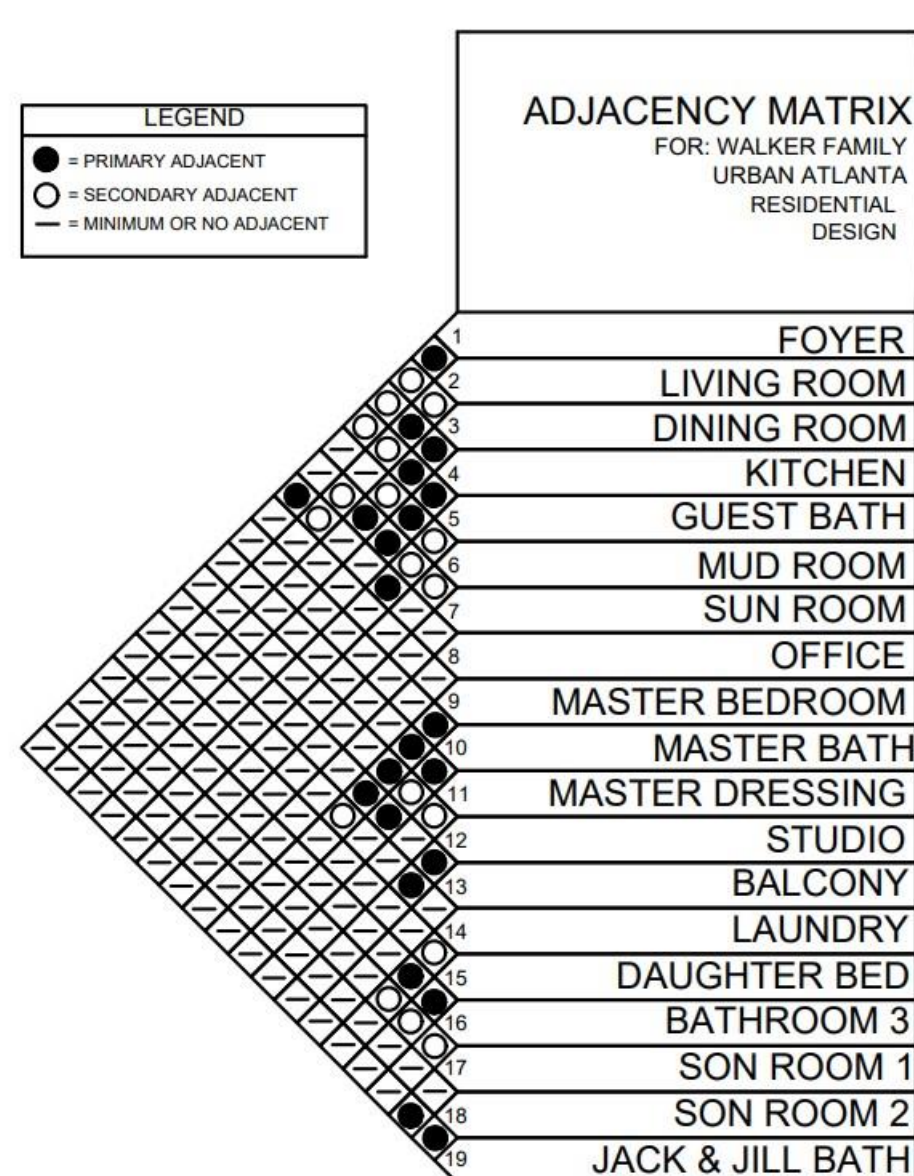
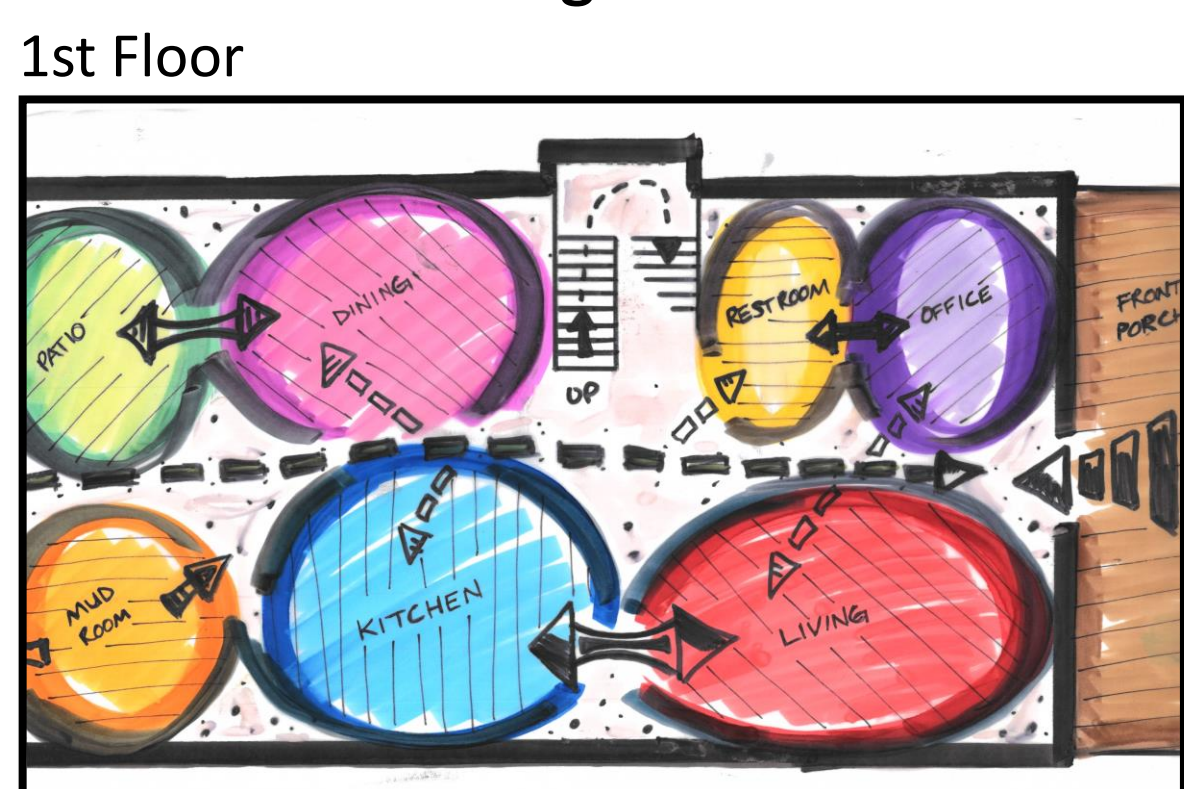

2nd Floor

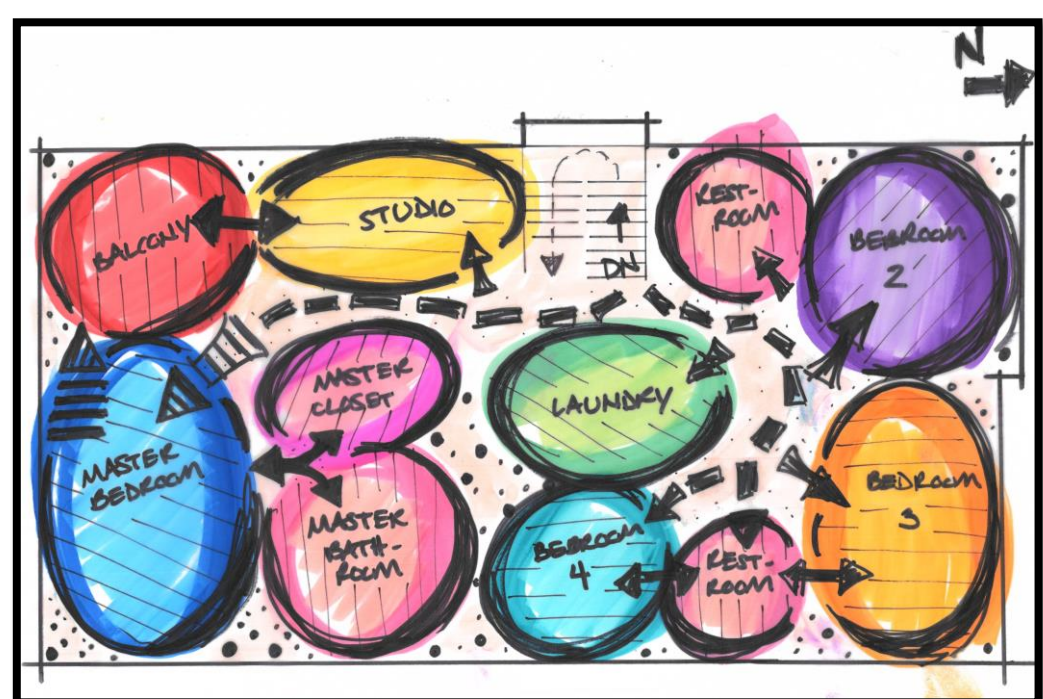

INSPIRATION



Block Diagrams

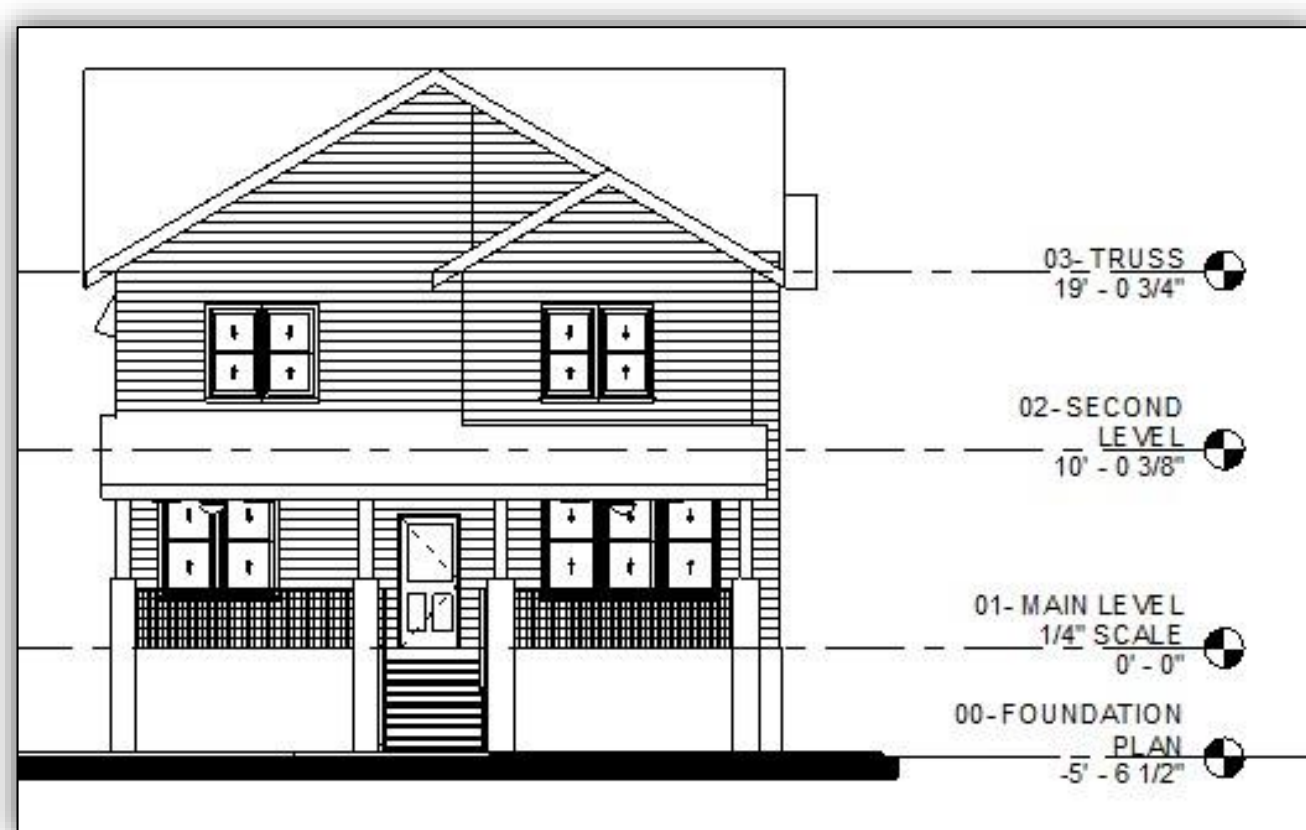
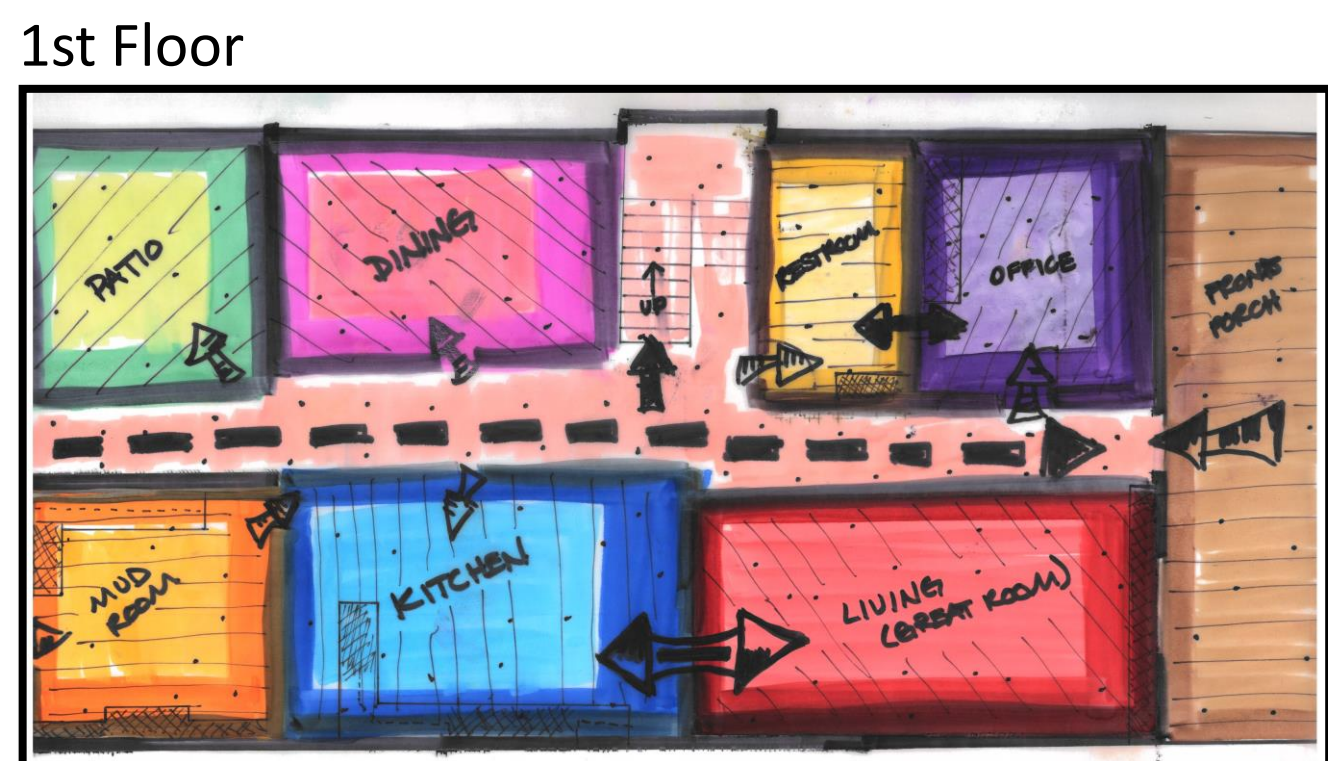

2nd Floor



EXTERIOR ELEVATION & PERSPECTIVE

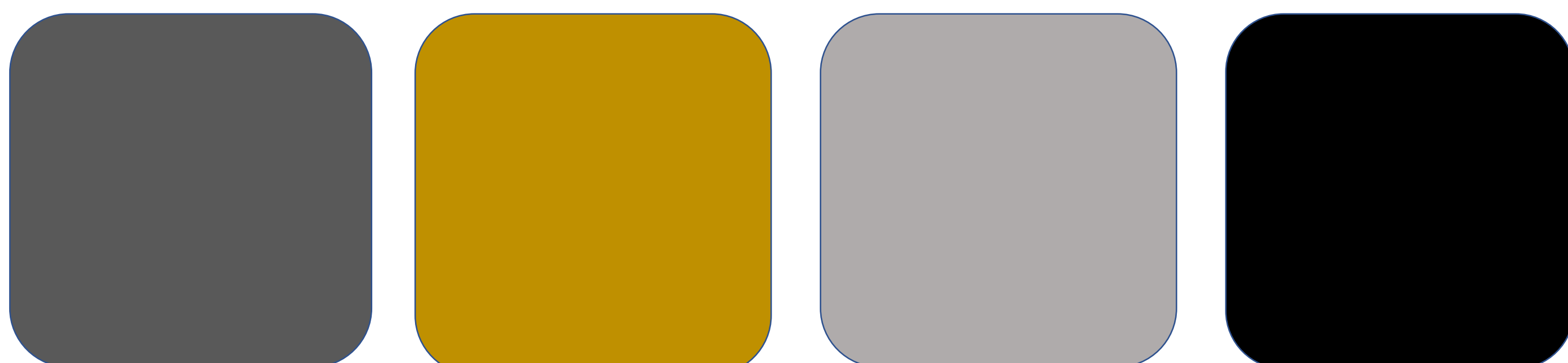

COLOR CONCEPT

1ST FLOOR WALKER RESIDENCE

Urban Atlanta House

Leonor Fleming

LIVING

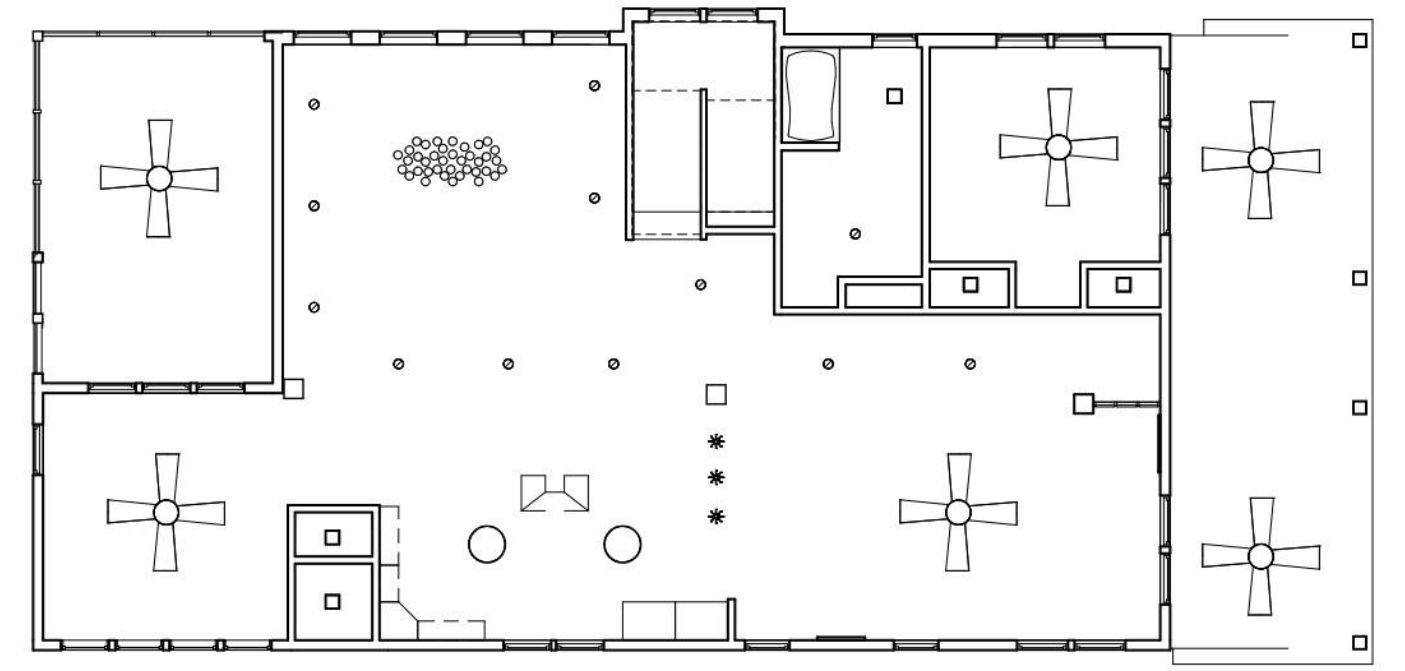

Reflective Ceiling Plan

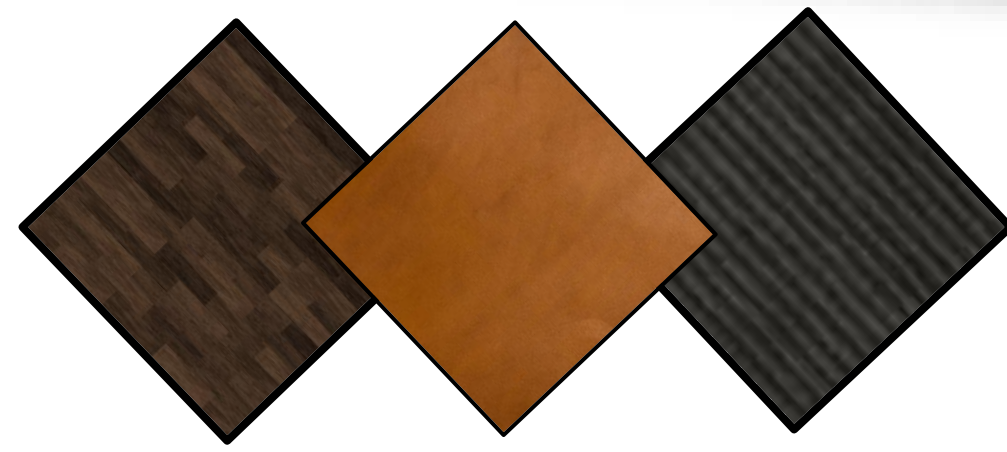

Floor Plan



Thermador

KITCHEN

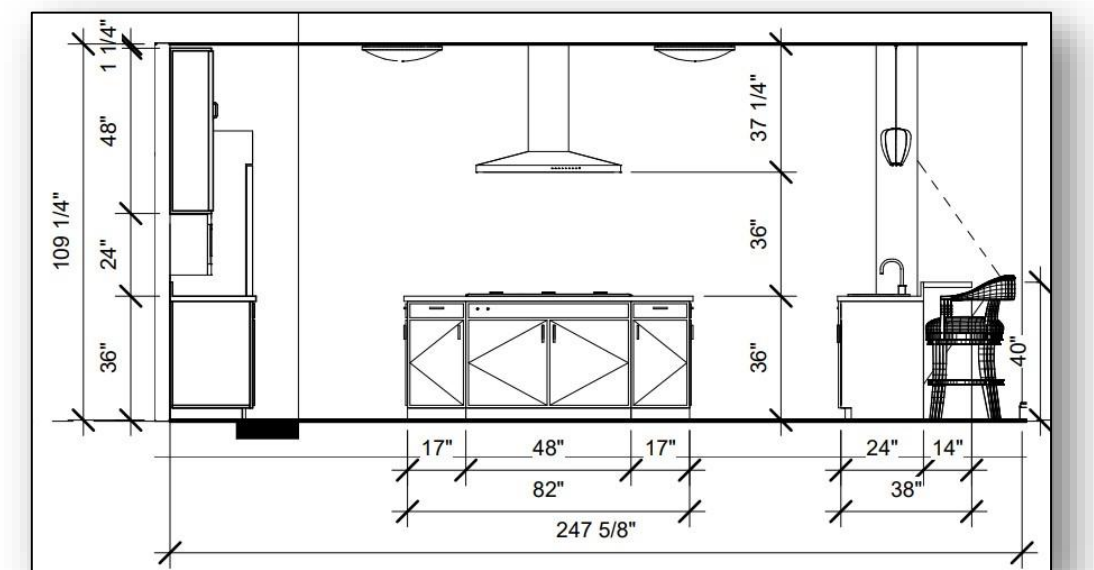
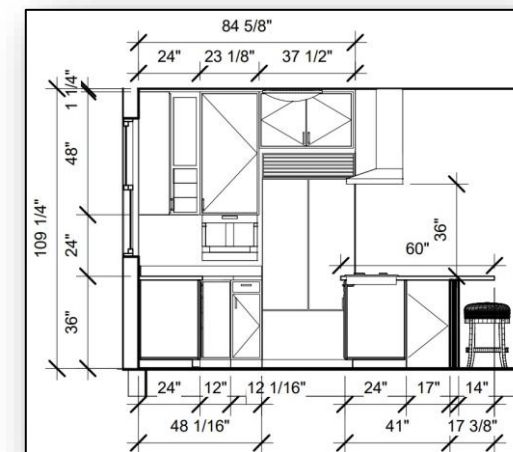
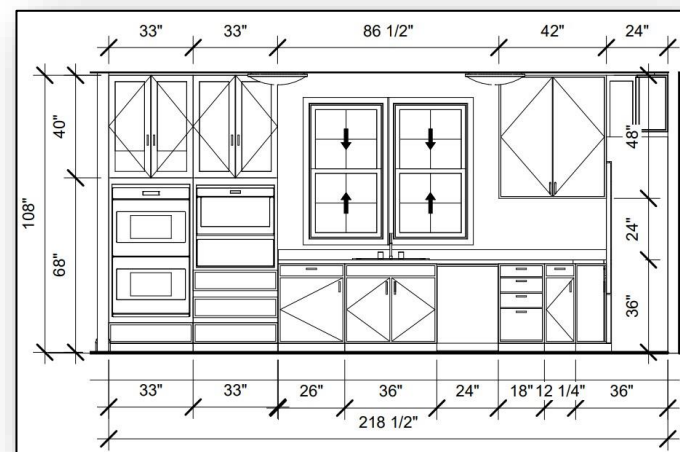
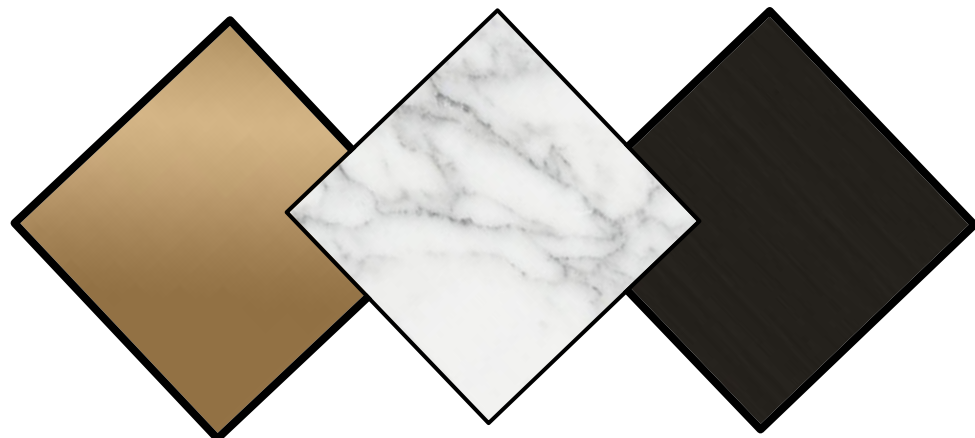

DINING

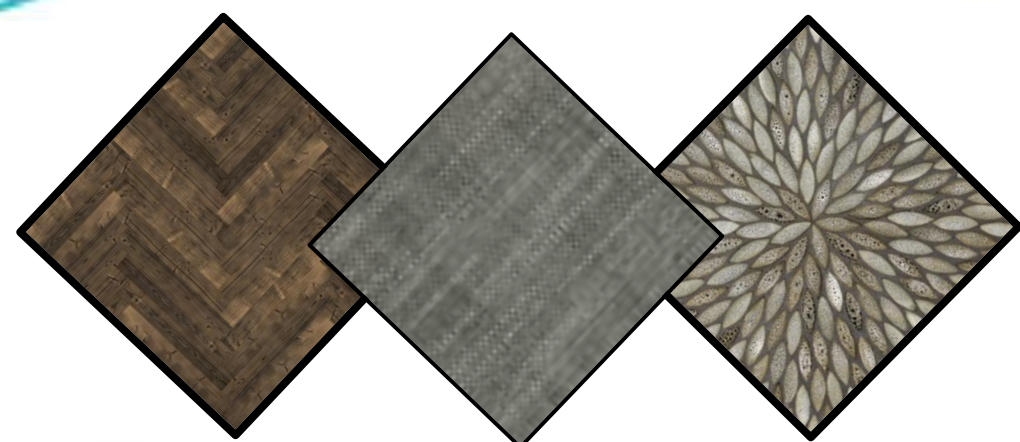

MUD ROOM



SUNROOM

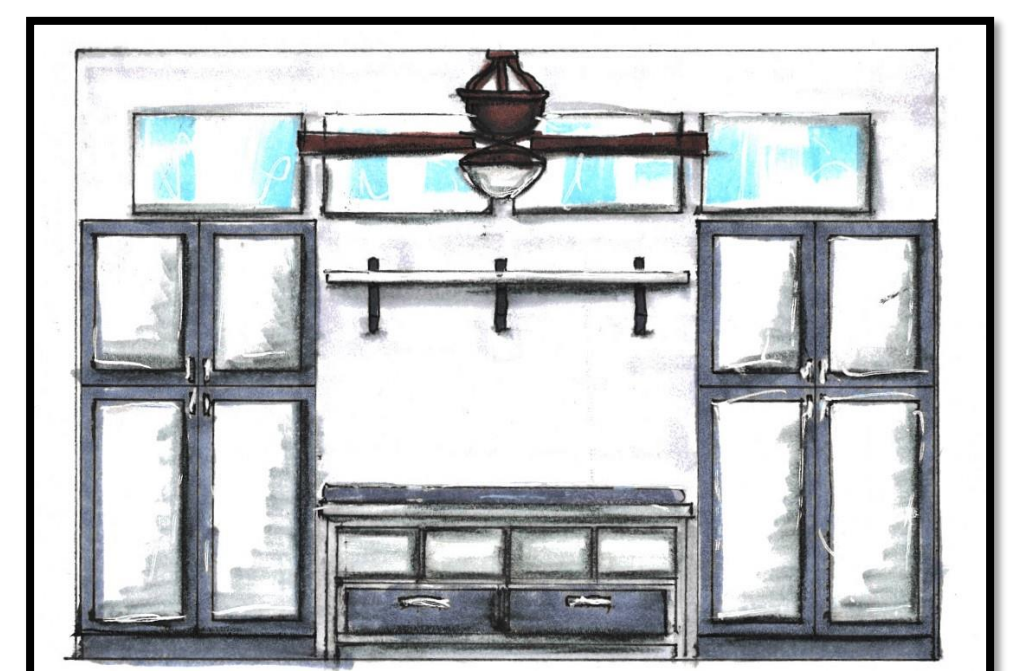
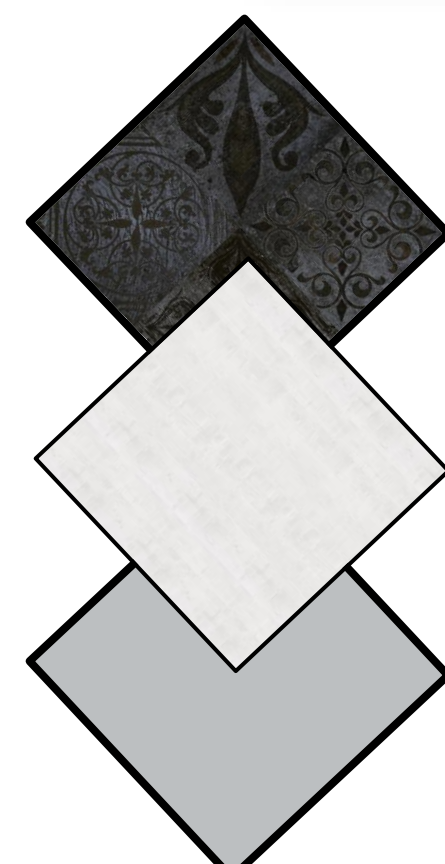

MASTER SUITE

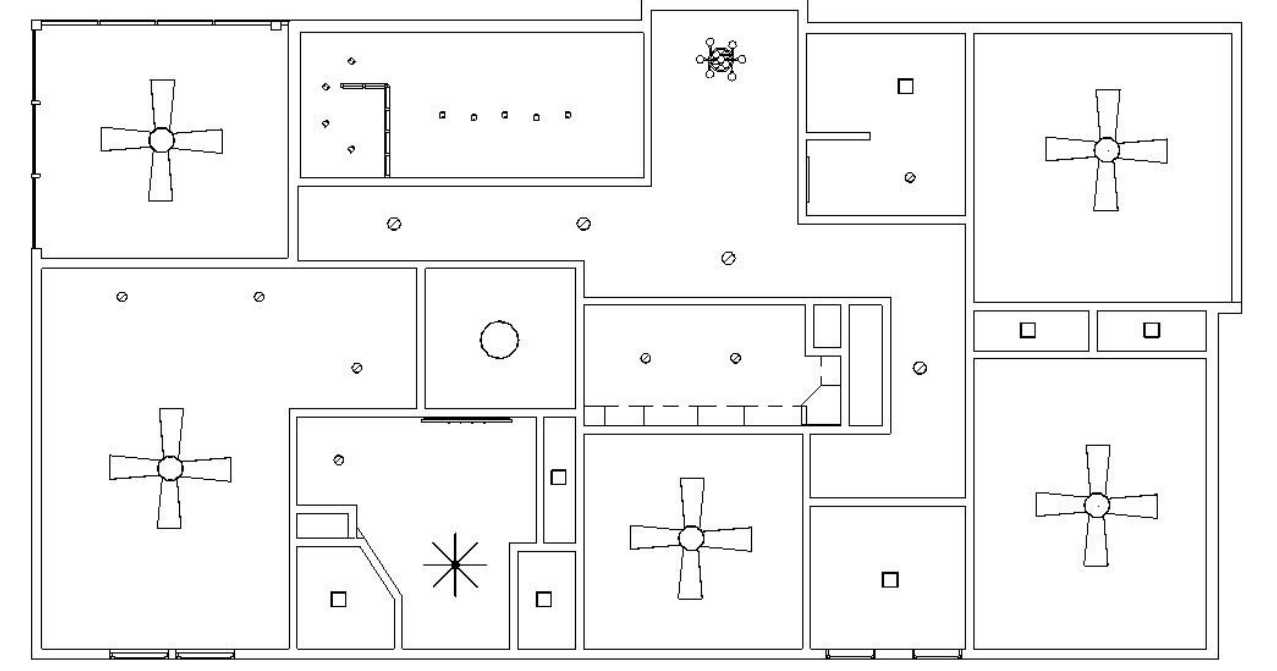

Reflective Ceiling Plan

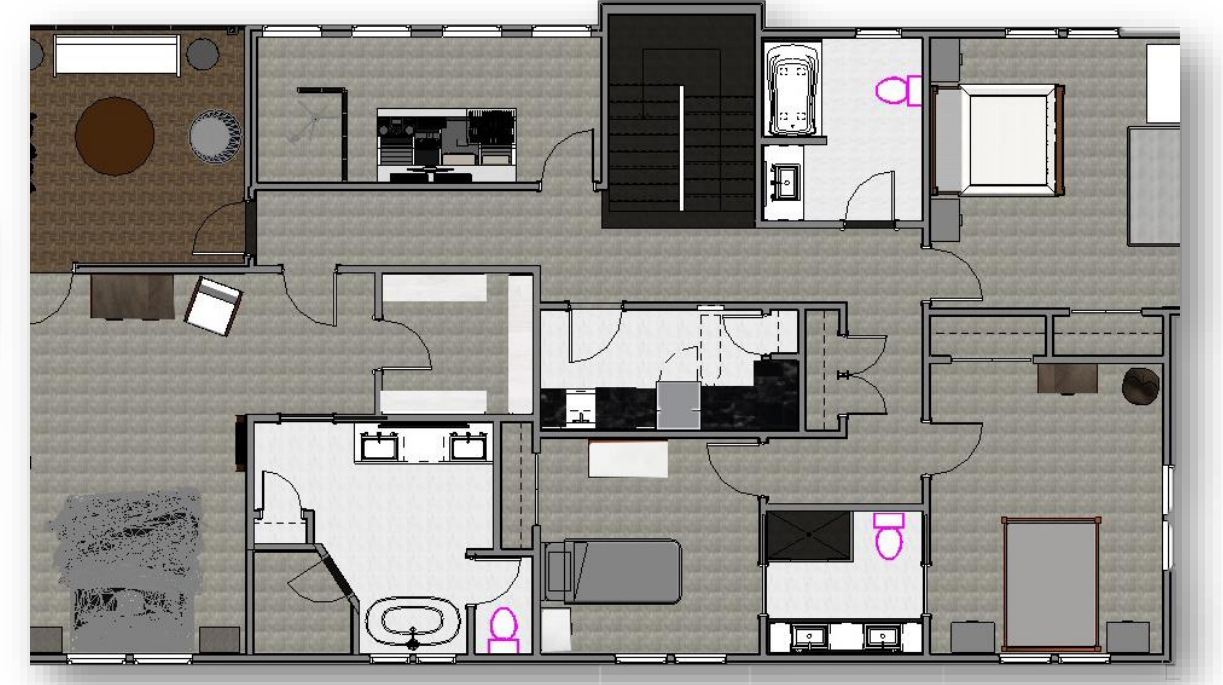
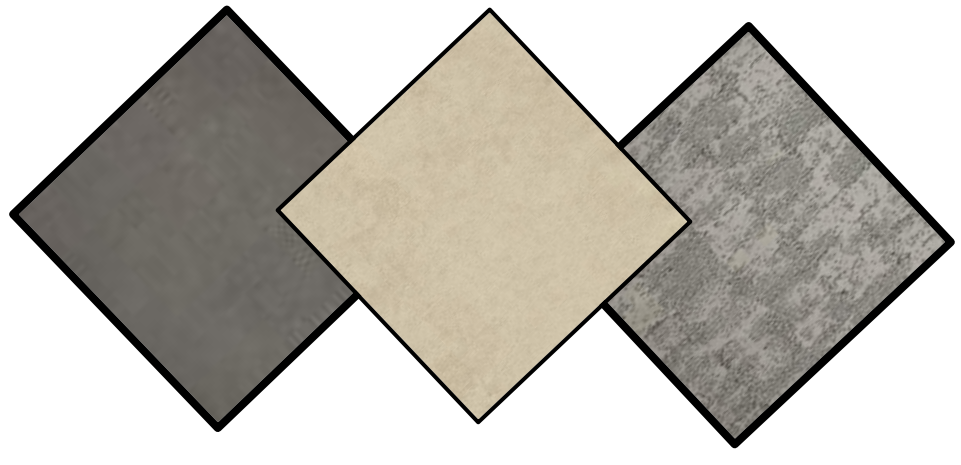

Floor Plan

MASTER BATH

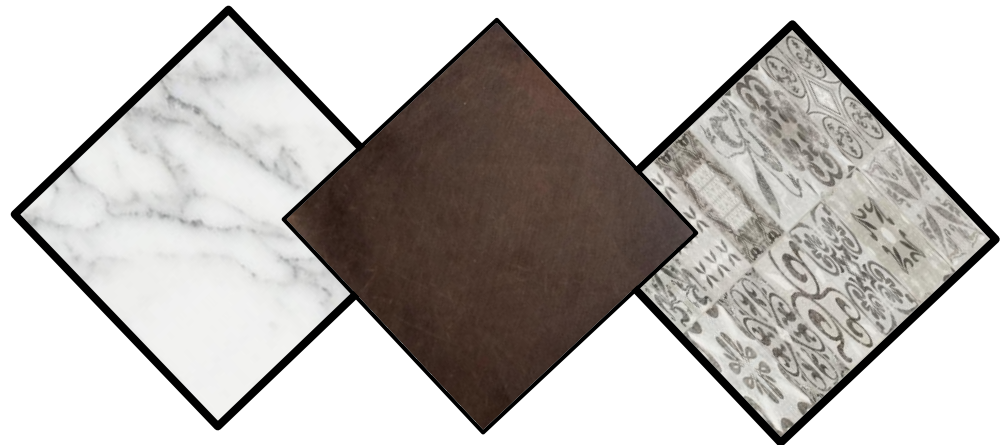
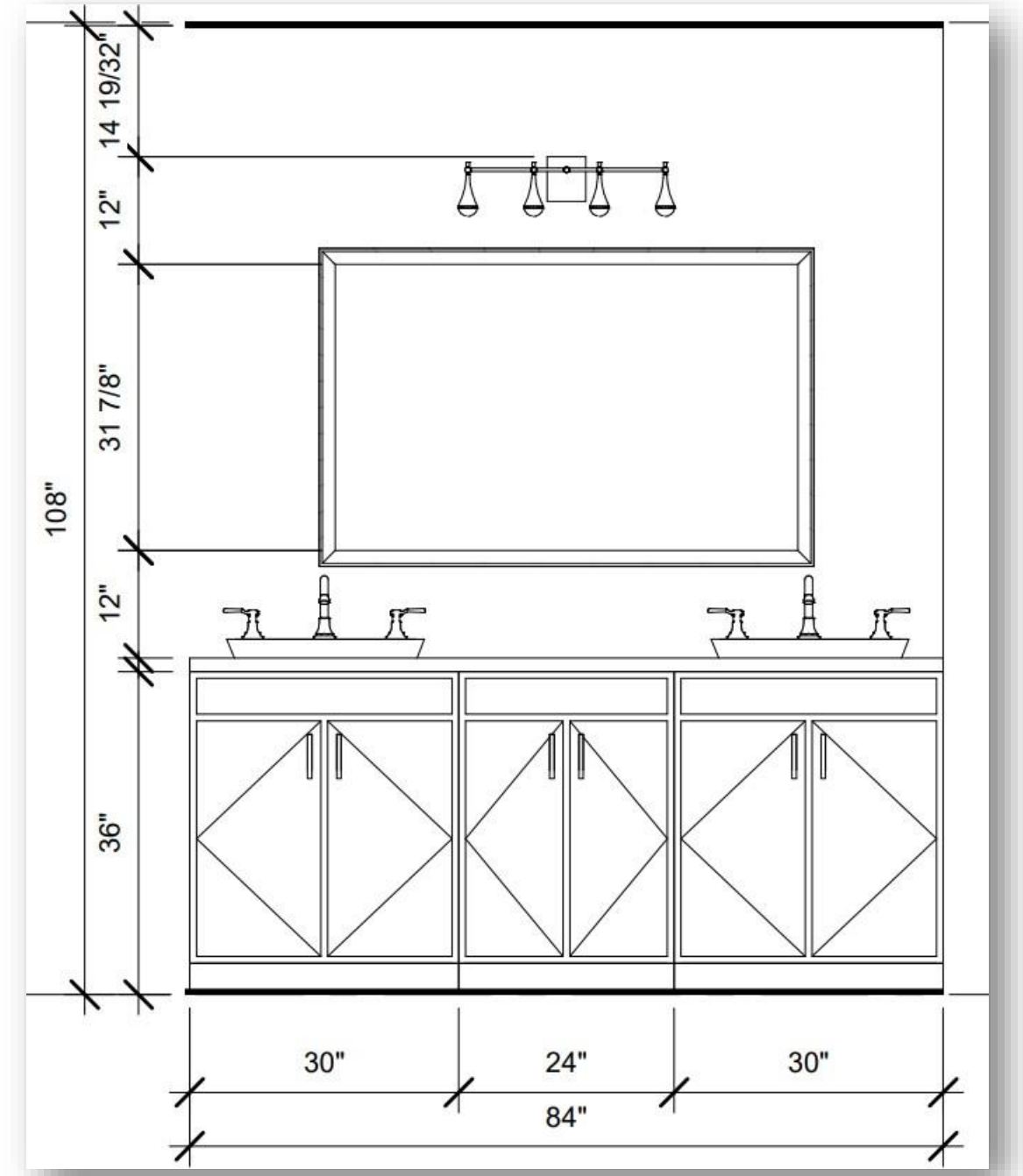
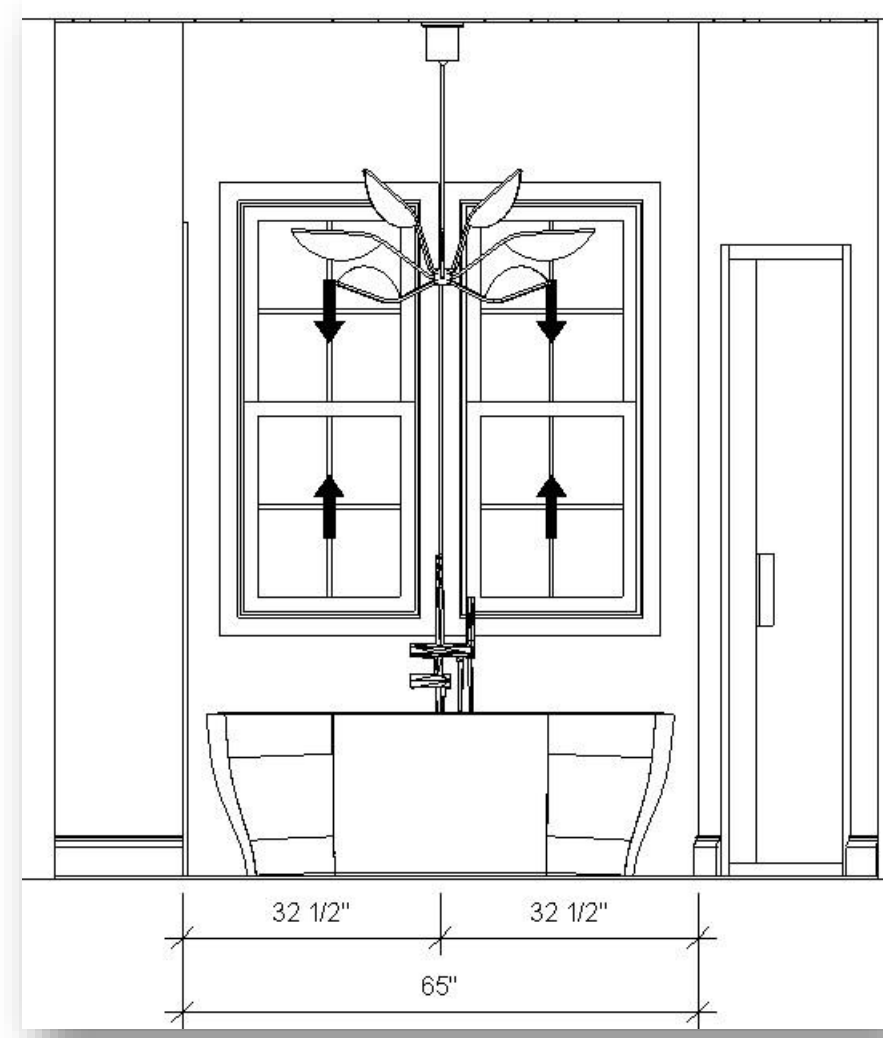

MASTER DRESSING



RECORDING STUDIO

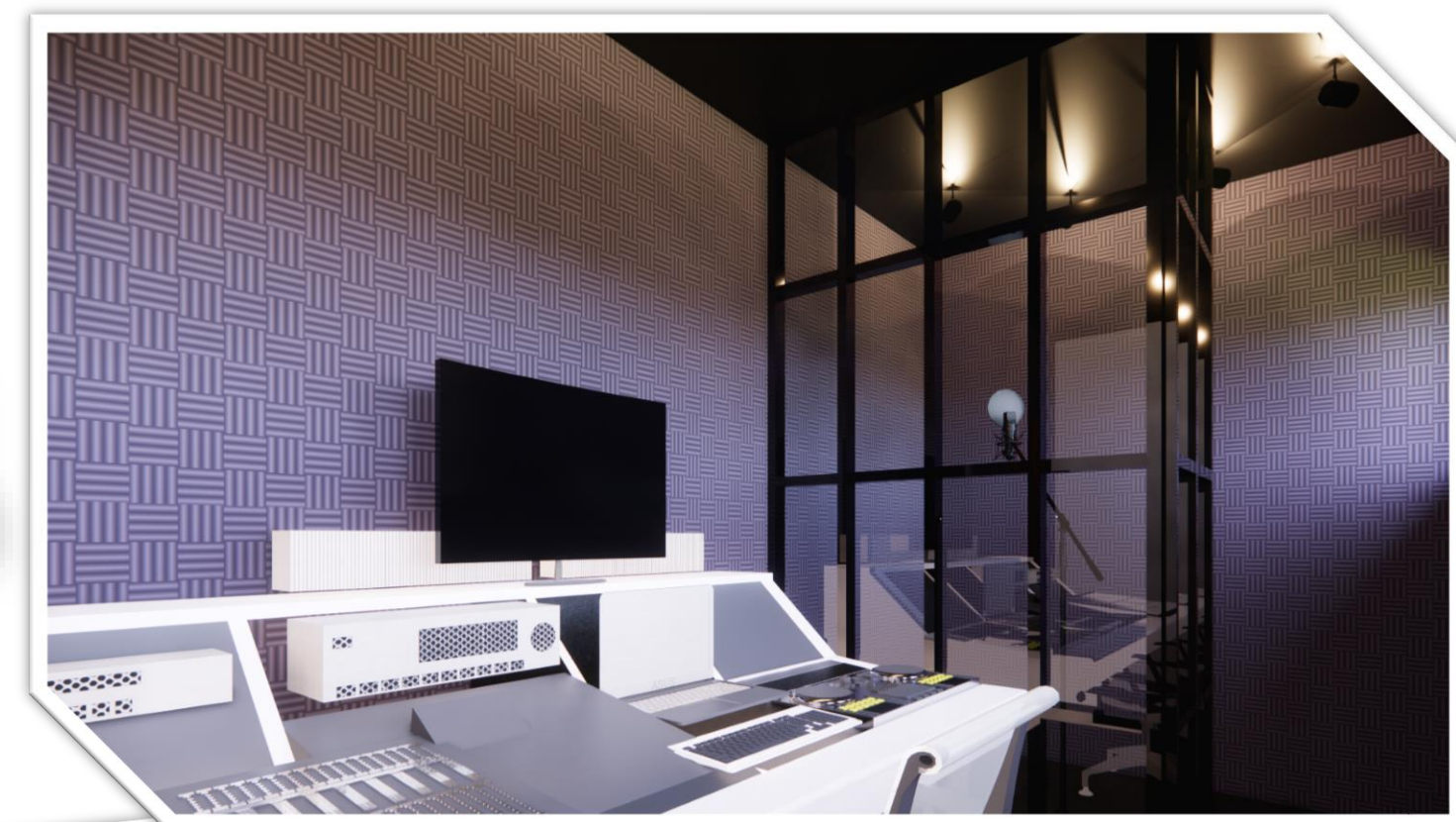

LAUNDRY

